











33 805 888



- Ausladung 166 mm
- schwenkbarer Auslauf 360°
- Laminarstrahl
- Armaturenhöhe 302 mm
- Höhe bis Laminarstrahlregler 185 mm
- Bohrungsdurchmesser 35 mm
- Durchfluss max. 8,3 l/min bei 3 bar Fließdruck
- bleifrei
- Dieses Produkt leistet einen Beitrag zur Erfüllung der Vorgaben von nachhaltigen Gebäudezertifizierungen, z.B. LEED®, BREEAM®, DGNB

	Chrom	33 805 888-00
	Platin gebürstet	33 805 888-06
	Platin	33 805 888-08
	Messing (23kt Gold)	33 805 888-09
	Dark Chrome	33 805 888-19
	Messing gebürstet (23kt Gold)	33 805 888-28
	Schwarz matt	33 805 888-33
	Champagne gebürstet (22kt Gold)	33 805 888-46
	Champagne (22kt Gold)	33 805 888-47
	Chrom gebürstet (Edelstahl-Look)	33 805 888-93
	Dark Platin gebürstet	33 805 888-99

Empfohlenes Zubehör

**Exzenterbetätigung mit Drehknopf - Chrom** 10 710 970-00



Empfohlenes Zubehör

**Spender mit Rosette - Chrom** 82 444 970-00



33 805 888

mm [inches]

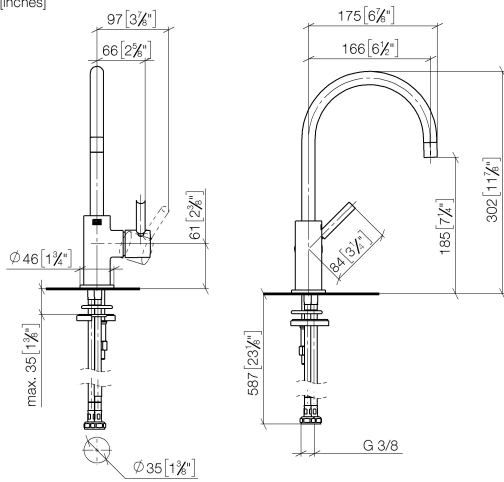

### Durchflussdiagramm

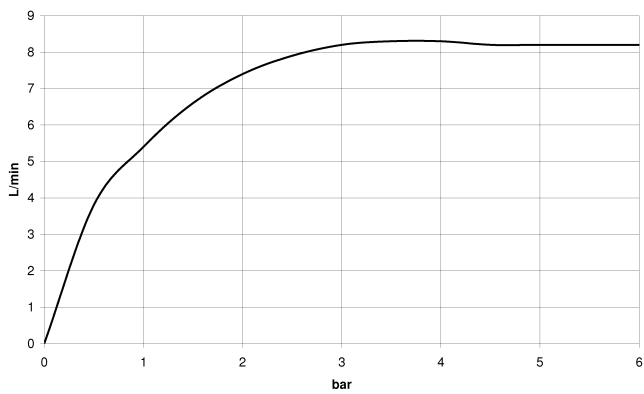

### Zertifikate

LGA\_38637.

WRAS\_240102012.

33 805 888

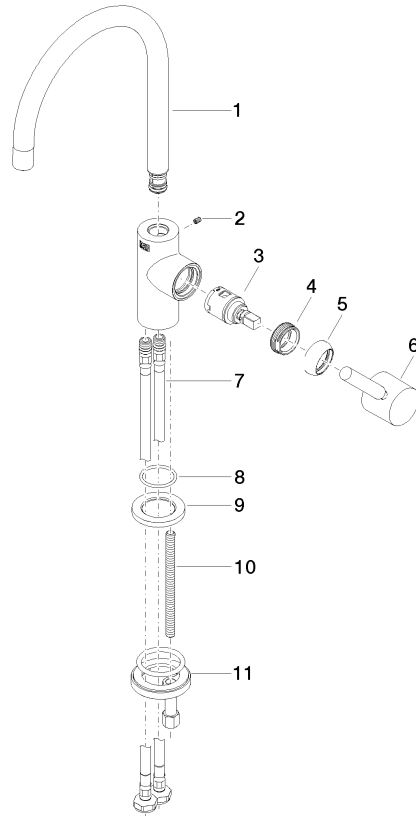

### Ersatzteilstückliste

Nr.	Artikelnummer	Benennung	Verbaumenge	Lieferzeit
1	90 28 22 393 00-00	Auslauf	1	-
Ersatzteil nicht mehr bestellbar, bitte bestellen Sie den Nachfolgeartikel				
2	09 31 11 008 90	Stift	1	2
3	90 15 05 042 00 90	Kartusche	1	2
4	09 24 04 266 90	Mutter	1	2
5	09 28 30 021-00	Haube	1	10
6	90 20 66 003 00-00	Griff	1	10
7	04 30 04 105 00 90	Schlauch	2	2
8	09 14 10 118 90	Dichtung	1	2
9	09 27 85 001-00	Rosette	1	10
10	09 31 11 012 90	Stift	1	2
11	04 30 11 038 64 90	Befestigungssatz	1	2